



# Andhra Pradesh State Road Transport Corporation

Office of VC&MD,  
RTC House, Vijayawada,  
Dt.25.04.2024.

No. TL6/359(02)/2024-MED

To

The DyCTM(MKTG),  
APSRTC, RTC House,  
Vijayawada.

**Sub: Hiring** – MSTC VII Hire bus tender notification – Communication of Revised interior themes for fabrication of AC Sleeper-GI (Vennela), AC Seater-GI (Indra) & Non-AC Sleeper-GI (Star Liner) bus bodies & Revised colour scheme for 40 seater Slux buses being fabricated under MSTC-VII Hire scheme - Reg.

Ref: This office letter even dated 20.02.2024.

\*\*\*\*\*

With reference to the subject, vide reference cited, the bus body specifications & drawings for AC Sleeper, Non-AC Sleeper, Indra AC Seater, Super Luxury-40-seater, UDLX, EXP, MEXP, PVG, UPVG & City Ordinary Buses on BS-VI chassis were communicated.

Further, it is to submit that, corporation had revised the interior themes (ACP Colours, Vinyl mat, Curtain colour and Foam Rexene for berths/back pad & AC Hatrack) for all three models of 12M bus bodies. The details of finalized interior themes are mentioned here under.

REVISED INTERIOR THEMES FOR 12 MTR BUS BODIES								
Type of body	ACP		Foam Rexene				Floor Vinyl	Curtains
	Roof & Partition	Truss Panel	Berth	AC Duct	Back pad center portion	Back pad flaps		
<b>AC &amp; Non-AC Sleepers</b>	VA 492 (Perlato Sicilia Marble)	VA 487 (Italian Crema Marble)	Polka Ivory	Polka Maroon	Polka Ivory	Polka Maroon	KL Grey	Light Blue-132, Beige-117
<b>Indra</b>	VA 492 (Perlato Sicilia Marble)	VA 487 (Italian Crema Marble)	--	Polka Maroon	--	--	KL Grey	Light Blue-132, Beige-117

Further, corporation had revised the Metallic PU paint shade code (Base coat) & also changed the graphics colour for Super Luxury buses & the colour scheme details for Super Luxury-40 seater buses along with graphics is furnished hereunder please.

S. No	Colour	Berger /Viton 2K Brand of colour code	Wuerth/ Glasurit Brand of HEX code
1	Half White	BRAP0204	FFFBF5
2	Purple	BRAP0436	8974F6
3	Dark Blue	BRAP0078	OB2E88
4	Maroon Red	BRAP0039	B4122D
5	Grey	BRAP0233	666666

This is for your information please.

ENCL: As above.

**Dy. Chief Mechanical Engineer(C&B)**

Copy to: CME(C&B) & CM(MRKT) for information please.

Copy to: All approved bus body fabricators.



# DETAILS OF GRAPHICS - SUPER LUXURY -40 Seater (AL)

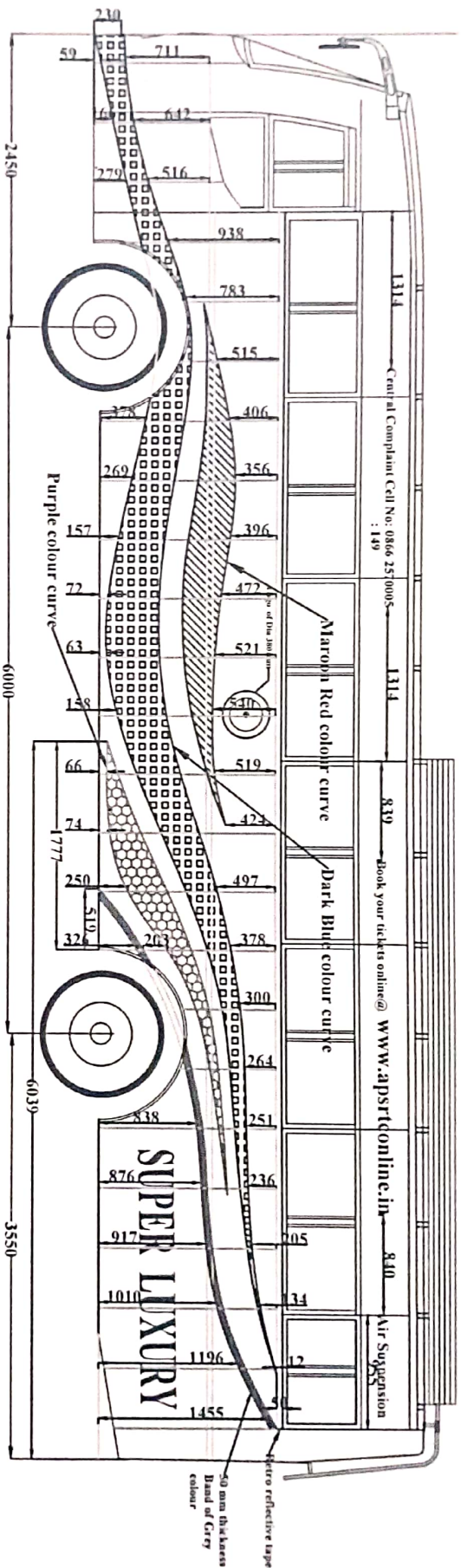

NOTE: 1. DIMENSIONS FOR EVERY 500 MM OF INTERVAL (FROM REAR END LAST PILLAR)  
 2. ALL DIMENSIONS ARE IN MM

BASE COAT - HALF WHITE - HEX CODE (GLASURIT) -FFFBF5

- PURPLE - HEX CODE - 8974F6 (GLASURIT)      - DARK BLUE - HEX CODE - OB2E88 (GLASURIT)

- MAROON RED - HEX CODE - B4122D (GLASURIT)      - GREY - HEX CODE - 666666 (GLASURIT)

*Handwritten signatures and dates:*  
 25/11/2021  
 25/11/2021

# DETAILS OF GRAPHICS - SUPER LUXURY (AL-40 Seater)

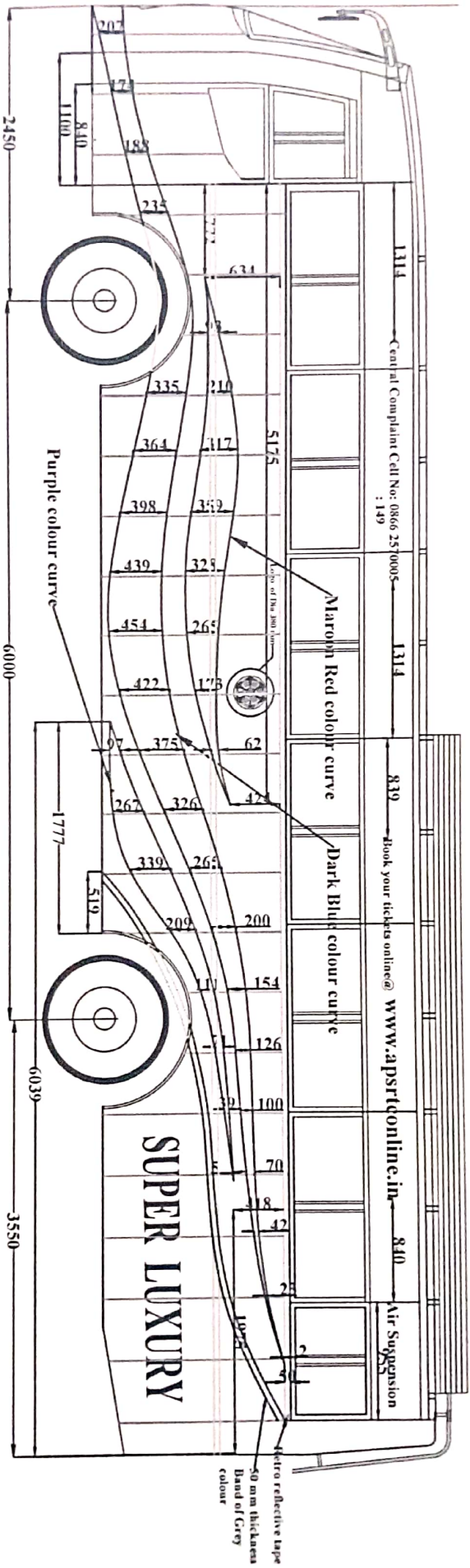

NOTE: 1. Dimensions taken for every 500 MM of interval (From Rear end Last pillar)  
 2. All Dimensions are in MM

 Air suspension — Font Style - Times New Roman  
 Font Colour - Blue

 SUPER LUXURY  
 Font Style - Times New Roman (Bold)  
 Font Colour - Red

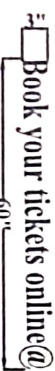
 Book your tickets online@  
 Font Style - Avantgrade BKBRT  
 Font Colour - White

 www.apstronline.in  
 Font Style - Avantgrade BKBRT  
 Font Colour - White

 Central Complaint Cell No: 0866 2570005 : 149  
 Font Style - Times New Roman  
 Font Colour - White

Handwritten notes: (EM) 25/12/24

Handwritten signature

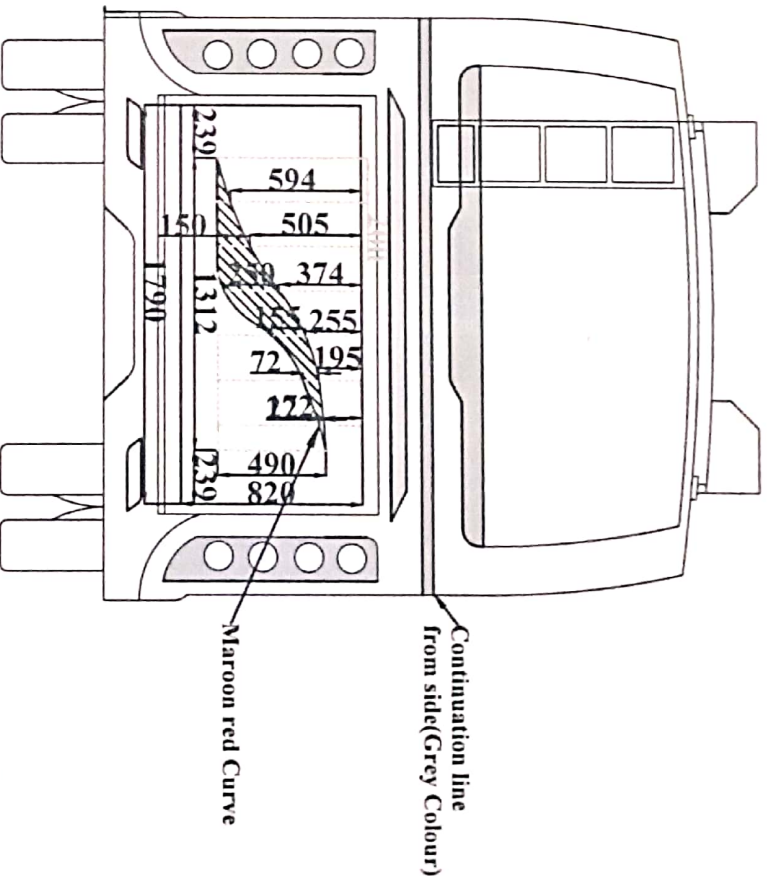
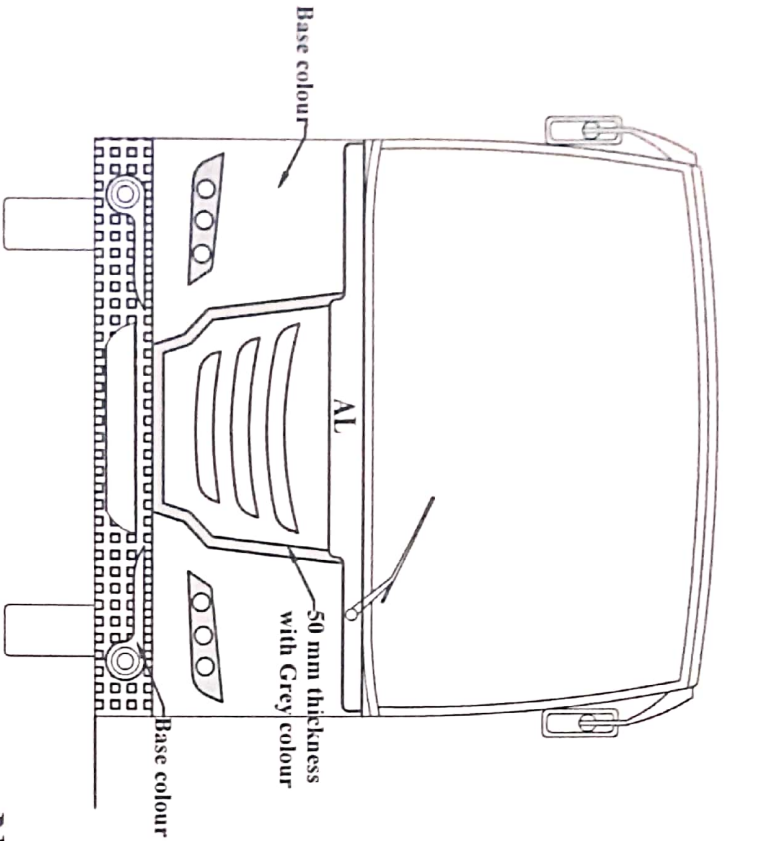

# DETAILS OF GRAPHICS - SUPER LUXURY (AL)



NOTE: Dimensions taken for every 200 mm of interval

BASE COAT - HALF WHITE - HEX CODE (GLASURIT) - FFFBF5

 - PURPLE - HEX CODE - 8974F6  
 - MAROON RED - HEX CODE - B4122D  
 (GLASURIT) (GLASURIT)

 - DARK BLUE - HEX CODE - 0B2E88  
 - GREY  
 - HEX CODE - 666666  
 (GLASURIT) (GLASURIT)

  
 AETRY  
 251427  
